

VS500 SQe

PRODUCT SHEET (ERV)

POSTHEATER CHARACTERISTICS

Electric

Phase	1Φ
Voltage	240 VAC
Frequency	60Hz
Rated Input	7,684 BTU
Total Current	9.78 A

Hydronic

Connection Diameter	0.5"
H ₂ O Pressure Loss	1.49 PSI
Air Pressure Loss	PSI
Rated Input	22,402 BTU
Water Flow	1.28 GPM



SUPPORTED ACCESSORIES

- CO₂ Sensor*
- Smarter Building Controller

* Pre-installed in all units

MODELS

- w/ No Postheater
- Hydronic Postheater
- Electric Postheater



2828 SW Corbett Ave, Suite 119
Portland, OR 97201
1-888-VENTIL8 (888-836-8458)
ventacity.com



UL 1812, CSA 22.2 No. 113

SPECIFICATIONS

Ventilation Flow – Max	539 cfm
Ventilation Flow – Typical	117 to 500 cfm
Ventilation Type	Energy Recovery Ventilator (ERV)
Heat Exchanger	Counterflow Polymer Static Plate
Fan Type	Backward Curved, Centrifugal, EC
Heat Recovery – Max	Sensible – 86% Latent – 79% Total – 83%
Temperature Range	40° F to 104° F
Humidity – Inside Max	90% RH
Operation Modes	CAV, DCV, Economizer
Noise	31 – 40 dBA
Duct Connection (Room Air, Supply Air)	None
Duct Connection (Outside Air, Exhaust Air)	12.4" Dia. (121 in ²) Min.
Discharge Air Temperature Control	Continuously Variable Bypass

MECHANICAL

Weight	288 lbs
Shipping Weight	450 lbs
Dimensions	84.3" L x 44.0" W x 17.9" H
Shipping Dimensions	92" L x 60" W x 29" H
OA Filter (Actual Size)	15.16" x 16" W x 3.75" MERV13
RA Filter (Actual Size)	10.6" L x 16.7" MERV8
Base Anchor Dimension	30.1" x 82.9"
External Finish	Powder Coat Over Aluminum

ELECTRICAL

Postheater	Electric	None/H ₂ O	Electric	None/H ₂ O
Voltage	240 VAC	240 VAC	208 VAC	208 VAC
Phase	1Φ	1Φ	1Φ	1Φ
Power Supply	5.1 kW	2.8 kW	3.9 kW	2.2 kW
FLA – Max	20.9 A	11.5 A	18.9 A	10.7 A
MCA	26.1 A	13.9 A	23.1 A	12.9 A
MOP	25 A	20 A	25 A	20 A
De-Ice Preheater	2.1 kW	2.1 kW	1.6 kW	1.6 kW
Post Heater	2.4 kW	0 kW	1.7 kW	0 kW
Fan Motor Type	EC			
Maximum Power per Fan	322 W (0.43 hp)			

VS500 SQe

PRODUCT SHEET (ERV)



An ultra-efficient energy recovery ventilator (ERV) and intelligent dedicated outdoor air system (DOAS) for ductless installation, the Ventacity VS500 SQe is a ductless ERV for decentralized applications. Its minimal noise level makes it a perfect choice for classrooms, offices and conference rooms. The VS500 SQe optimizes for energy efficiency and healthy indoor air quality, while offering ultra-quiet operation and no drafts.



A part of the

HVAC²

NEXTGEN BUILDING SYSTEM™

Our ventilation equipment connects seamlessly to our building controls and cloud-based user interface to take HVAC systems to the next level of energy efficiency and control. We call this new system HVAC².

1-888-VENTIL8 (888-836-8458)
ventacity.com

VS500 S_Qe

PRODUCT SHEET (ERV)

PERFORMANCE



Exceptional energy efficiency performance puts the VS500 S_Qe in a class by itself.



With its polymer counterflow heat exchanger core, the VS500 S_Qe transfers 71-86% of the heat and 51-79% of the moisture between fresh and exhaust air streams.



Our fans incorporate electronically commutated motors (ECMs) and backward curving fan blades, reducing the power required for air movement.

FAN OPERATING RANGE

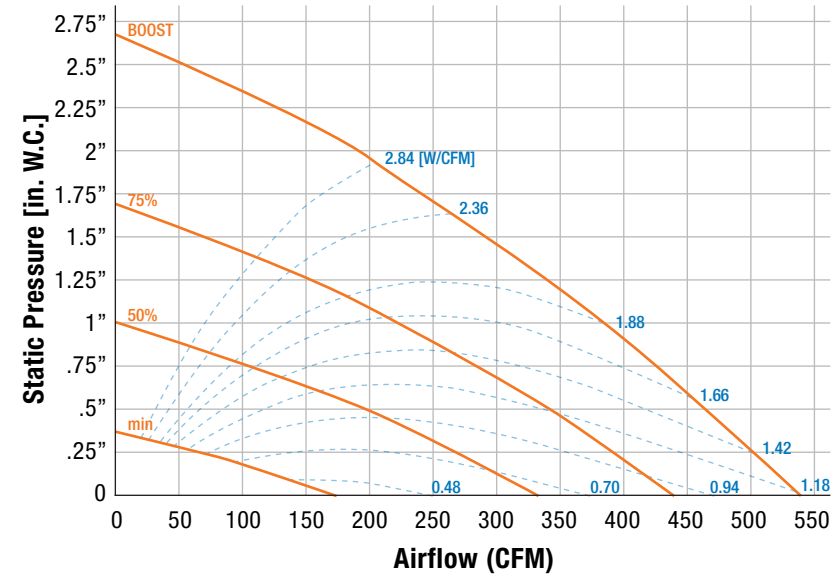

SOUND PERFORMANCE RADIATED FROM CASE

Fan Speed	CFM	Sound Power Per Frequency Band (Hz)								Overall		
		63	125	250	500	1k	2k	4k	8k	LWA [dB]	LPA [dB] ¹	LPA [dB] ²
25%	180	20.0	38.0	46.6	28.3	22.4	21.9	28.1	27.0	47.3	32.6	24.7
50%	307	34.5	41.1	43.2	33.3	31.9	29.6	27.4	25.9	46.2	31.5	23.6
75%	464	40.5	44.1	48.7	41.5	40.0	37.5	29.8	26.6	51.5	36.8	28.9
Boost	539	44.4	48.4	51.0	46.5	44.9	42.4	34.2	27.9	55.0	40.3	32.4

¹Sound pressure levels calculated at 1 meter for Q = 4
²Sound pressure levels calculated at 3 meters for Q = 4

LATENT EFFICIENCY

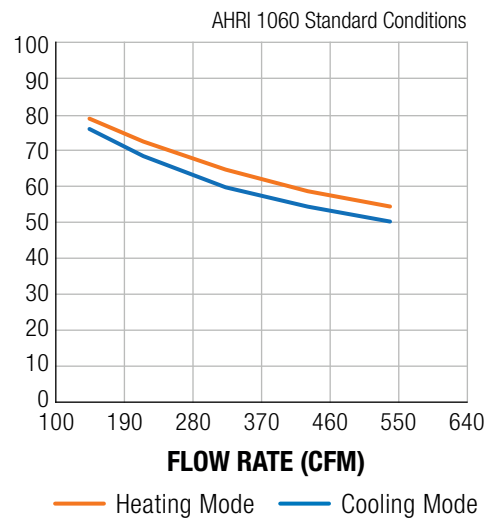

SENSIBLE EFFICIENCY

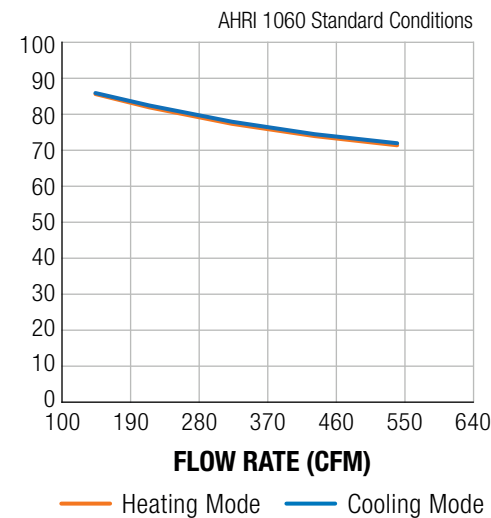

TOTAL EFFICIENCY

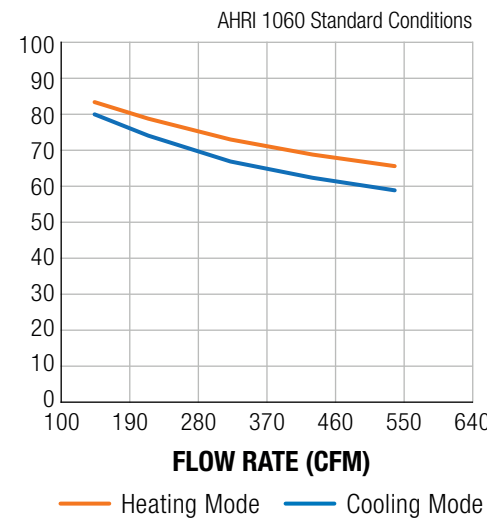

VS500 S_Qe

DIMENSIONS

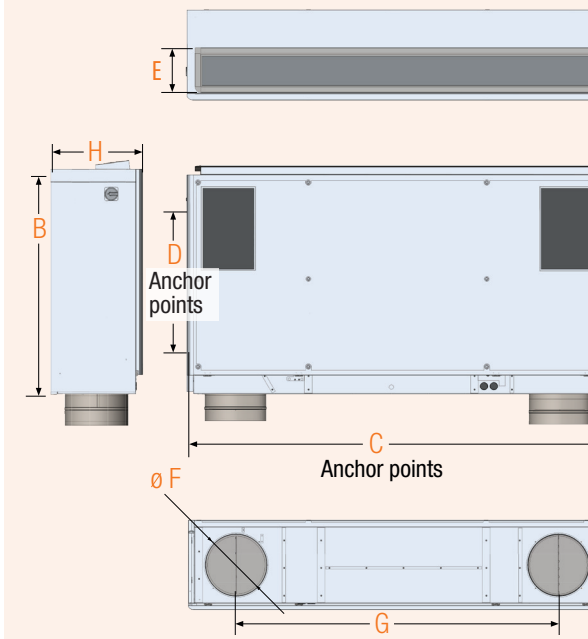

A	84.3"	E	8.8"
B	43.9"	F	12.4"
C	82.9"	G	64.9"
D	30.0"	H	17.9"

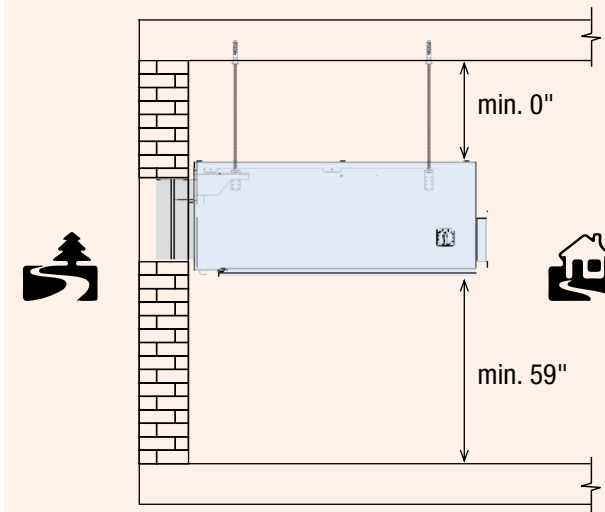

PARTS

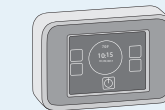
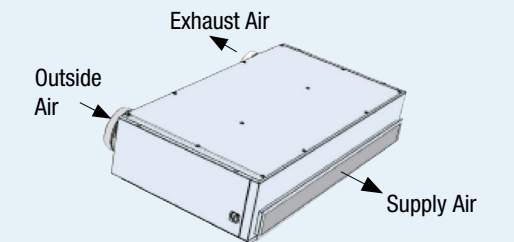
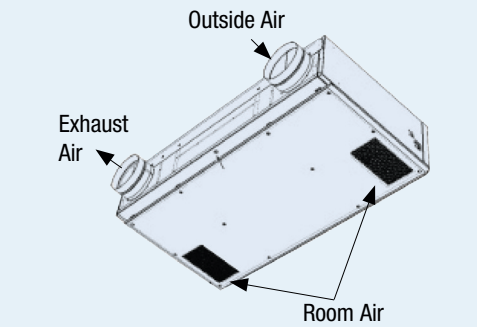

Control Panel



Condensate Drain Siphon

VENTACITY SYSTEMS
 ALWAYS HEALTHY • ALWAYS EFFICIENT™

2828 SW Corbett Ave, Suite 119
 Portland, OR 97201
 1-888-VENTIL8 (888-836-8458)
 ventacity.com

VS500 S_Qe
 PRODUCT SHEET (ERV)