

Inverter Driven Heat Pump

9,000 BTU Floor Mount Type

Job Name _____
 Location _____
 Engineer _____
 Submitted To _____
 Submitted By _____
 Reference _____

Date _____
 Approval _____
 Construction _____
 Unit No _____
 Drawing No _____

PRODUCT FEATURES

- Wireless remote controller
- Auto|Cool|Dry|Fan|Heat modes
- 24 Hr. timer
- Powerful mode
- Cold prevention
- Auto Restart



MODEL NUMBERS				
Indoor Unit			AGU9RLF	
Nominal Capacity			9,000	
LINESET REQUIREMENTS				
Connection Method			Flare	
Liquid			Ø1/4 (Ø 6.35)	
Gas	in (mm)		Ø3/8 (Ø 9.52)	
Drain hose	Material		PVC	
	in		Ø 9/16 (I.D.), Ø 11/16 (O.D.)	
	mm		Ø 13.8 (I.D.), Ø 16.7 (O.D.)	
INDOOR DIMENSIONS & WEIGHT				
Net (H x W x D)	in		23-5/8 x 29-1/8 x 7-7/8	
	mm		600 x 740 x 200	
Gross (H x W x D)	in		27-9/16 x 32-5/16 x 12-3/16	
	mm		700 x 820 x 310	
Net Weight	lb (kg)		31 (14)	
Gross Weight			37 (17)	
ELECTRICAL SPECIFICATIONS				
Voltage/Frequency/Phase			208/230 V ~ 60 Hz	
Voltage Range			187-264 V	
Running Current	A		0.15	
Input Power	W		16	
SOUND PRESSURE				
Indoor Unit	Cooling	High	dB (A)	39
		Medium		34
		Low		28
	Heating	Quiet		22
		High		39
		Medium		35
		Low		30
		Quiet		22
FAN DATA				
Airflow Rate	Cooling	High	CFM (m3/h)	312 (530)
		Medium		259 (440)
		Low		212 (360)
		Quiet		159 (270)
	Heating	High		312 (530)
		Medium		270 (460)
		Low		224 (380)
		Quiet		159 (270)

Warranty Information



7 Year Compressor, 5 Year Parts out-of-the-box Warranty



10 Year Compressor, 10 Year Parts Warranty when registered within 30 days of installation in a residence



12 Year Compressor, 12 Year Parts Warranty when registered within 30 days of installation in a residence, and installed by a Fujitsu Elite contractor

ENCLOSURE

Enclosure	Material	Polystyrene
	Color	White

ACCESSORIES

UTY-TTRX	3rd Party Thermostat Converter
UTY-RNNUM	Wired Remote
UTY-RVNUM	Wired Remote w/backlight
UTY-RSNUM	Simple Remote
UTY-XWZXZ5	Dry Contact Wire Kit
FJ-RC-WIFI-1NA	Intesis Wired WiFi module
FJ-IR-WIFI-1NA	Intesis IR WiFi module



ETL#: 3170288

Due to continuous product improvements, specifications are subject to change without notice. Please log in to the Fujitsu Portal for the most up-to-date documentation <https://portal.fujitsugeneral.com>

Effective Date: 10/4/2019 Version AGU9RLF -2019B

DIMENSIONS

Units: In. (mm)

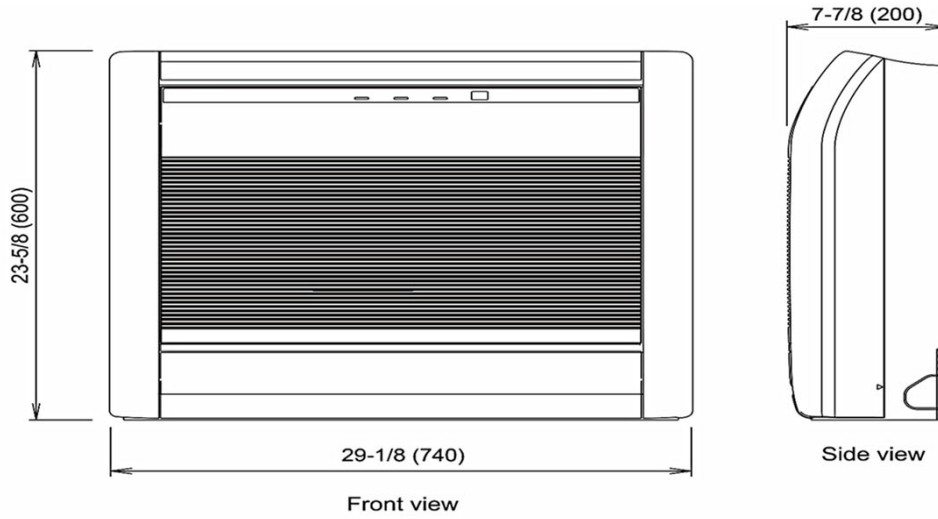

■ INSTALLATION PLACE

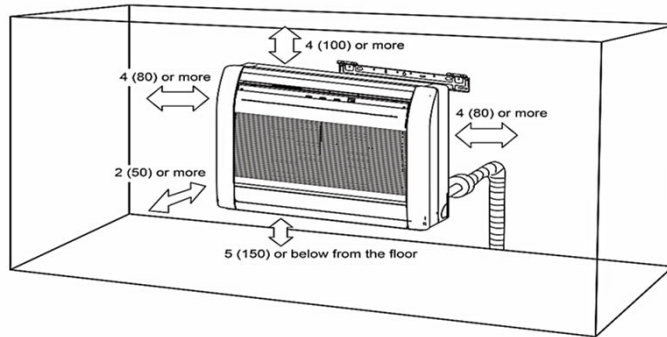

The Fujitsu logo is a worldwide trademark of Fujitsu General Limited. The Halcyon logo and name is a worldwide trademark of Fujitsu General Limited and is a registered trademark in Japan, the USA and other countries or areas. Copyright 2018 Fujitsu General America, Inc. Fujitsu's products are subject to continuous improvements. Fujitsu reserves the right to modify product design, specifications and information in this brochure without notice and without incurring any obligations.

Note: Specifications are based on the following conditions:
 Cooling: Indoor temperature of 80°F (26.7°C) DB/67°F (19.4°C) WB, and outdoor temperature of 95°F (35°C) DB/75°F (23.9°C) WB. Heating: Indoor temperature of 70°F (21.1°C) DB/60°F (15.6°C) WB, and outdoor temperature of 47°F (8.3°C) DB/43°F (6.1°C) WB. Pipe length: 25ft. (7.5m), Height difference: 0ft. (0m) (Outdoor unit - indoor unit).